

STANDARD CLOUD INSTALL GUIDE

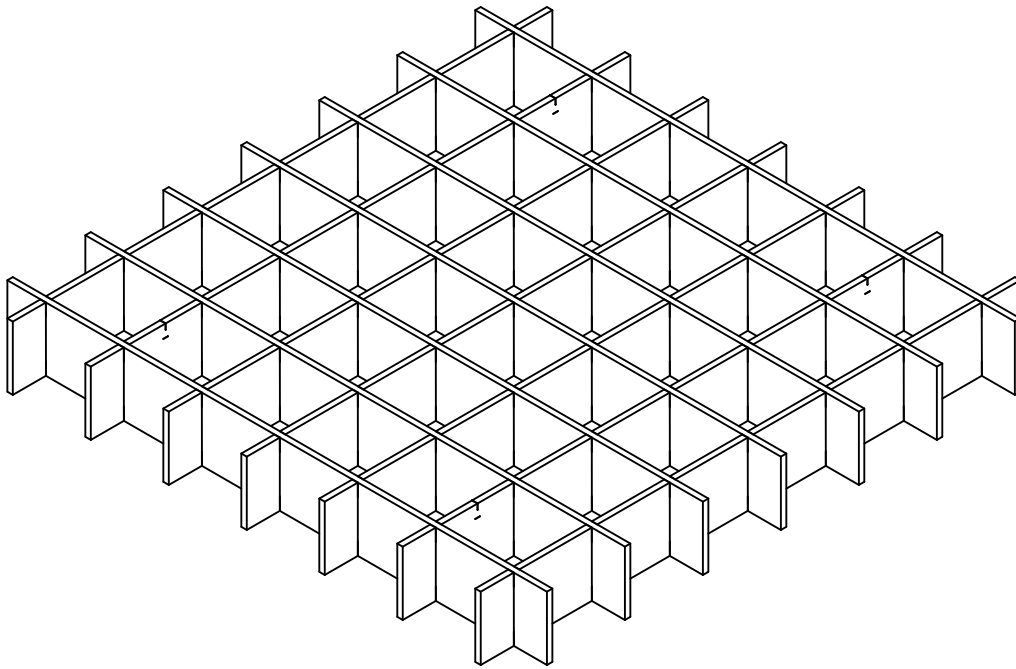

baresque.com.au
e info@baresque.com.au
p 1300 306 399

STANDARD CLOUD ASSEMBLY

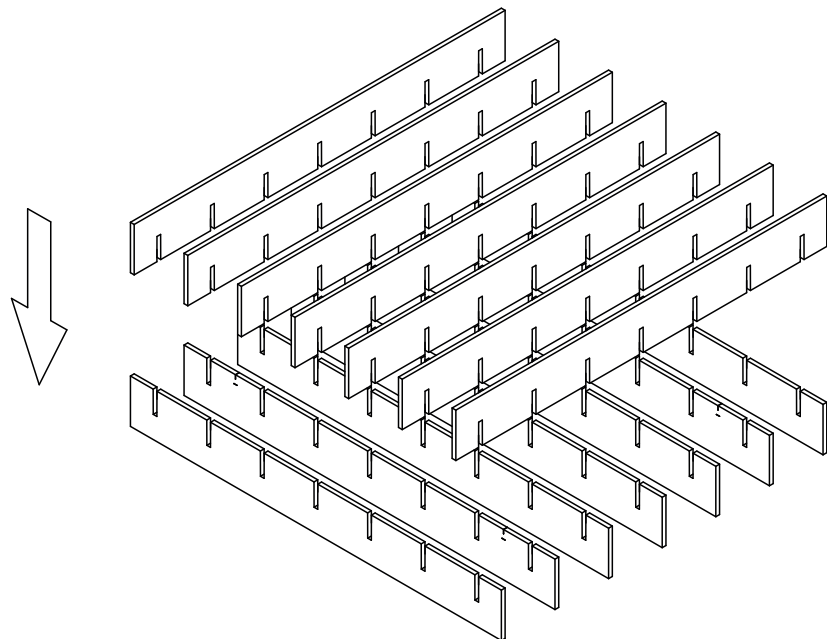

1) Assemble cloud profiles via slots.
Note position of mounting slits.

STEP 1

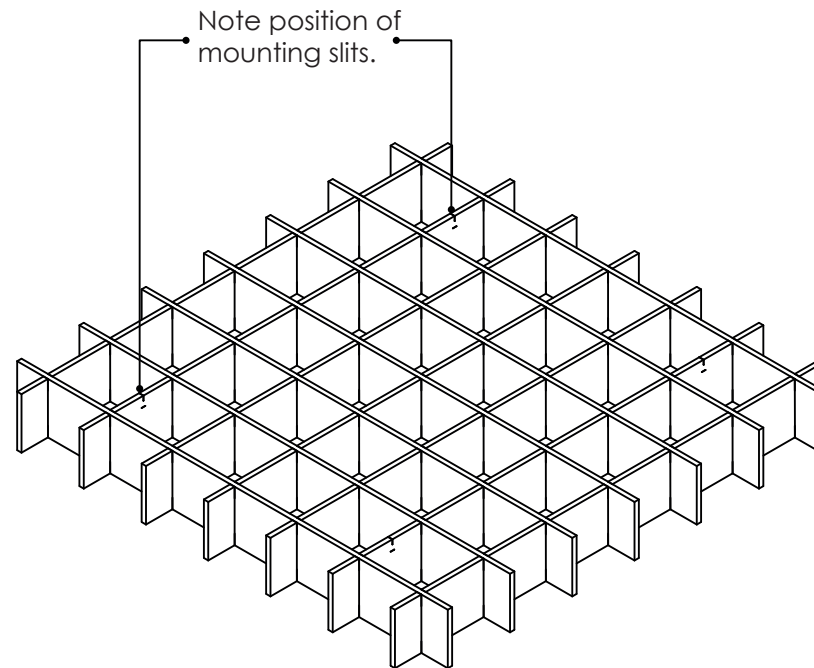

2) Assembled "Standard Cloud".

STEP 2

STANDARD CLOUD SUSPENSION METHOD

3) Place cloud assembly up to ceiling in desired location. Mark position of **4 off** through holes which correspond to the mounting slits.

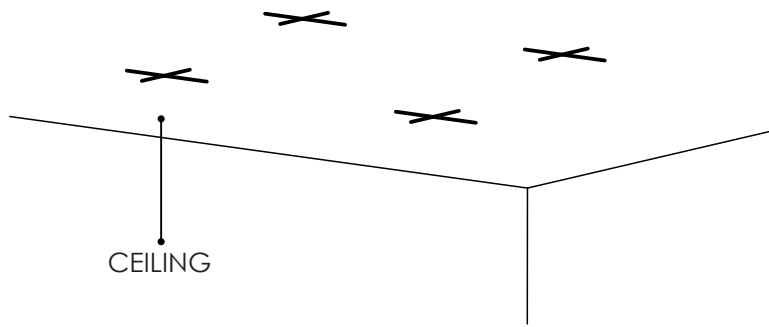

4) Consulting the “**Baresque Systems Fixing Directory**”, select the appropriate fixing method for your substrate & install **4 off** ‘hanger heads’. **Please note, screws are not supplied.**

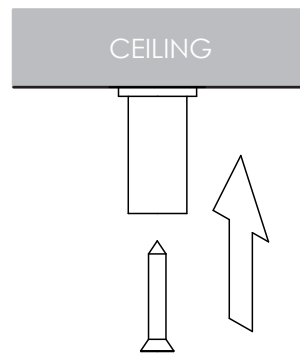

STEP 3 & 4

5) Feed swaged wire through tip of ‘wire adjuster’ (as shown). Push button (shown in grey) to adjust wire length. Release the button to lock in place.

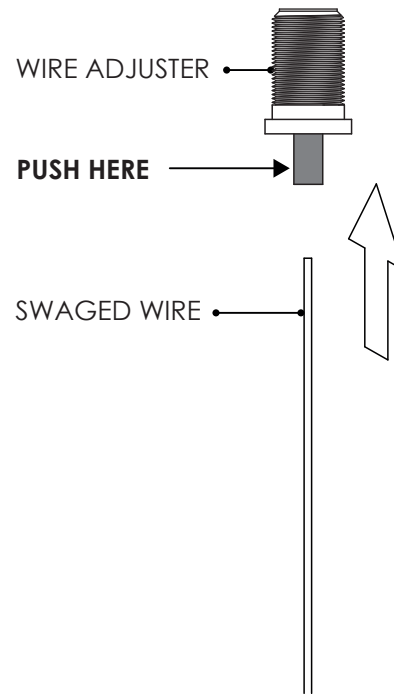

6) Feed swaged wire through hole in the side of ‘hanger head’. Screw ‘wire adjuster’ into ‘hanger head’, then adjust wires so they finish at approx. the same length.

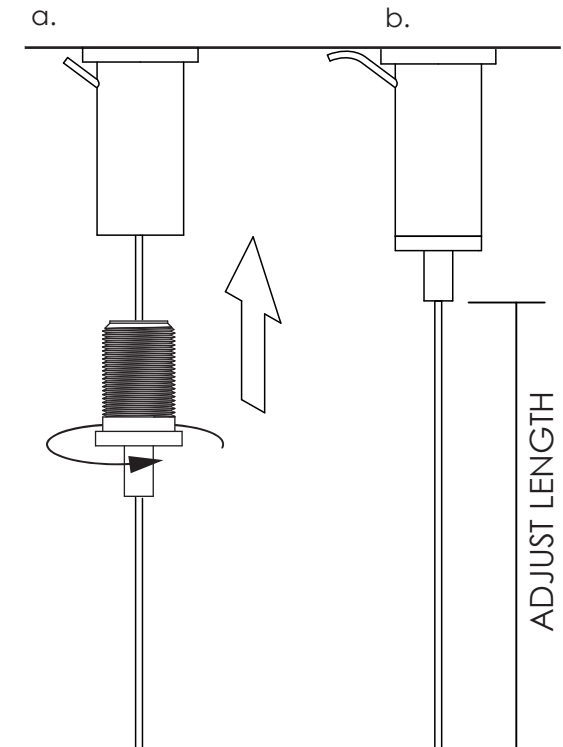

STEP 5 & 6

STANDARD CLOUD SUSPENSION METHOD

7) Insert 'S' hooks into mounting slits on cloud as shown.

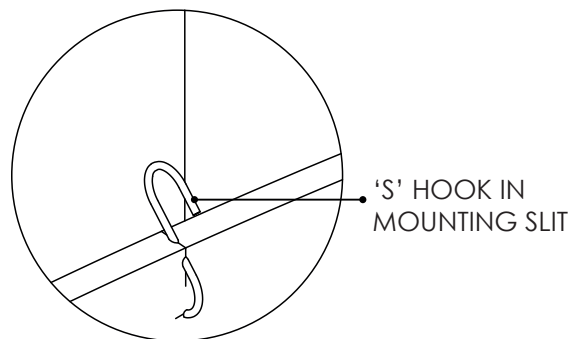

8) Suspend cloud by looping 'S' hooks through swaged wire.

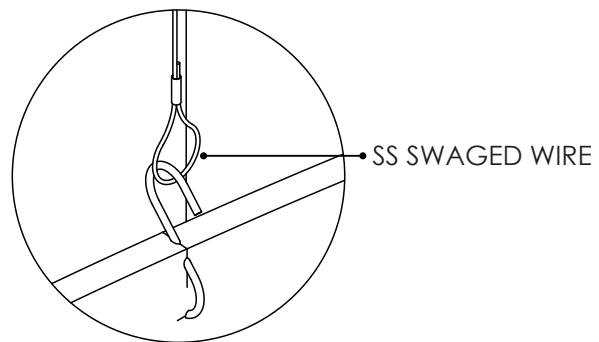

STEP 7 & 8

9) Re-adjust wire length as explained in STEP 5 until cloud hangs level. Trim excess wire for a neat finish.

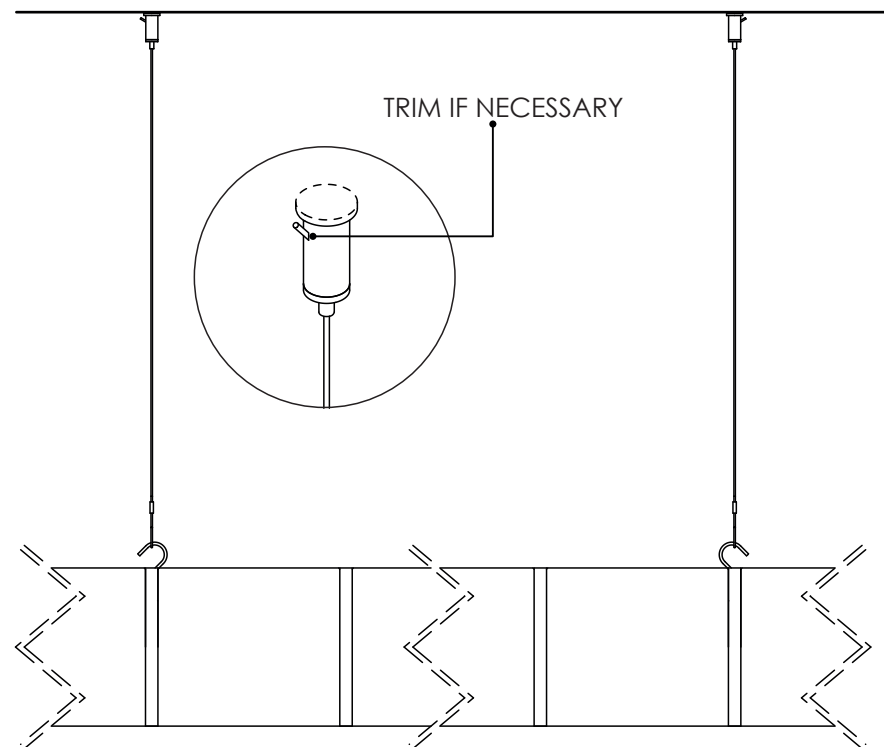

STEP 9

STANDARD CLOUD PARTS

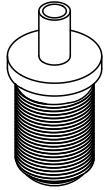

WIRE ADJUSTER
4 OFF

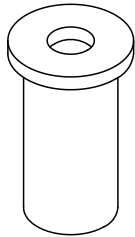

HANGER HEAD
4 OFF

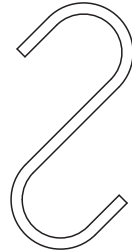

'S' HOOK
4 OFF

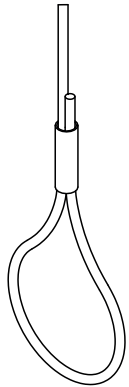

SWAGED WIRE
4 OFF

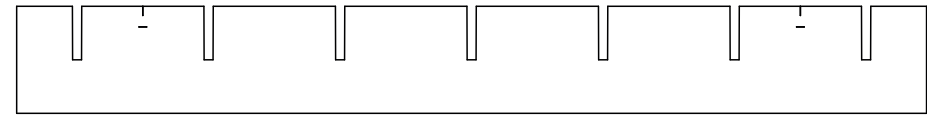

MOUNTING PROFILE: 2 OFF

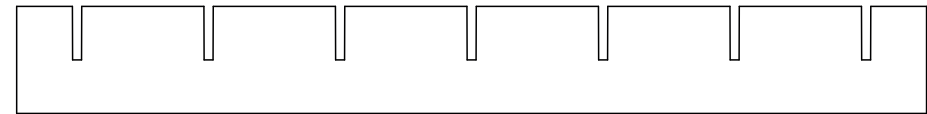

STANDARD PROFILE: 12 OFF