

baresque

baresque.com.au

e info@baresque.com.au

p 1300 306 399

LUCERE

handling fabrication and installation guide

PLEASE CAREFULLY INSPECT THE LUCERE PRODUCT PRIOR TO INSTALLING, CUTTING, DRILLING OR FABRICATING AND INFORM BARESQUE (Baresque Australia - +612 9966 8470) IMMEDIATELY OF ANY DAMAGE OR DEFECTS. FAILURE TO DO SO MAY JEOPARDIZE YOUR RIGHTS TO WARRANTY REPLACEMENT AND / OR REIMBURSEMENT FOR SHIPPING DAMAGE.

To ensure your satisfaction, the following information is provided to guide you in the proper care and handling of Lucere.

handling	p. 1 - 4
fabrication	p. 4 - 8
Installation	p. 9 - 10
repairs and scratch removal	p. 10 - 11

handling

Baresque Lucere panels will arrive with protective masking applied to the finished surfaces. This masking should remain in place for as long as possible, and only be removed when absolutely necessary. The masking can be removed by peeling it from the surface. Never use scrapers or sharp objects to remove this masking.

Panels can have sharp edges, and large panels can be heavy. Suitable precautions should be exercised at all times and hand protection should be used when moving and handling the material. Do not use suction cups or hooks to move material and take care not to scratch the surface or chip the edges. When handling unmasked sheets, make sure hands are clean and oil free: cotton gloves are recommended.

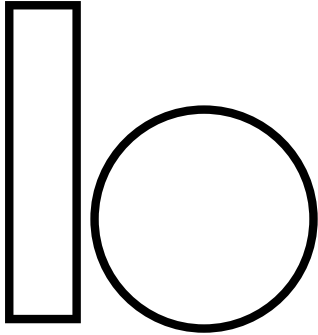

baresque

baresque.com.au

e info@baresque.com.au

p 1300 306 399

LUCERE

handling fabrication and installation guide (cont.)

If lifting devices are not available, Baresque Lucere panels can be unloaded manually. However, it is very important to follow special procedures for your safety:

- Handle one sheet at a time
- Sheet should be handled on the edge
- Carry Vertically
- Always have heavy-duty protective gloves and proper safety shoes
- Two people

Sheets should be carried one at a time on edge with one hand under to support and one hand for control.

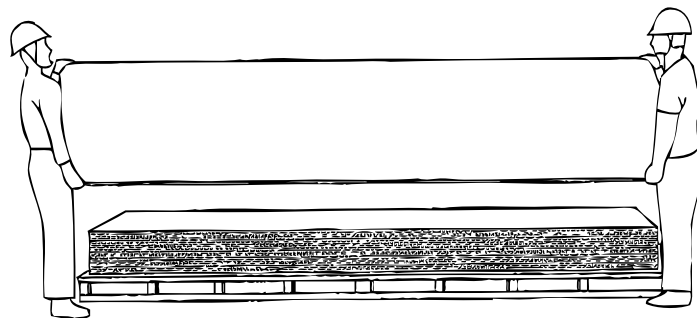

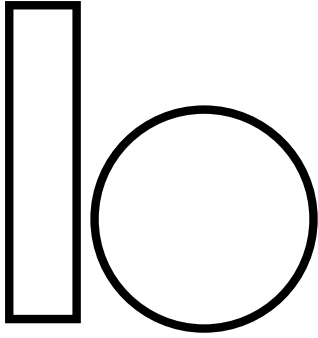

baresque

baresque.com.au

e info@baresque.com.au

p 1300 306 399

LUCERE

handling fabrication and installation guide (cont.)

STORAGE

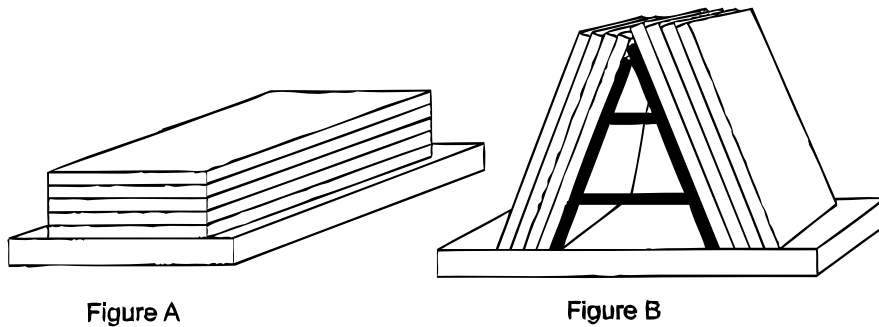

Baresque Lucere panels must be stored in a dry place. It is advisable to place a polyethylene cover over the stack when a sheet is removed, to reduce moisture absorption. It is recommended that sheets should be stored horizontally on their original delivery pallets, and that the pallets be placed on horizontal storage shelves. It is strongly recommended that pallets should not be stacked, which carries the risk of creating internal tensions and spoiling the flatness of the sheets. Please see figure A.

If a vertical storage method is adopted, it is preferable that the sheets be leaned against solid supports inclined at approximately 80° to avoid any bending, the base of the sheet should be fully supported by flat floor or stable platform. As illustrated in figure B.

It is strongly recommended to avoid storage longer than 6 months.

Panels should be stored indoors in a cool, dry, well ventilated area out of direct sunlight and away from heat sources. Avoid temperature extremes during storage and allow the material to acclimate to ambient room temperature before installation.

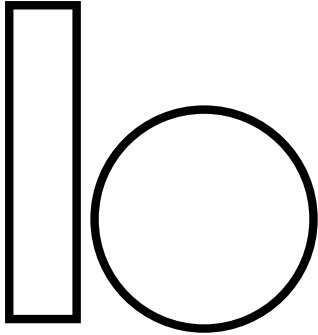

baresque

baresque.com.au

e info@baresque.com.au

p 1300 306 399

LUCERE

handling fabrication and installation guide (cont.)

Protective foam should be used between all layers of material during storage, and the factory installed masking should remain in place. Do not allow water to come into direct contact with the material during storage. This could cause the material to warp, stain, or delaminate, and may make the masking difficult to remove.

fabrication

All of Baresque's Lucere panels enables on-site cutting, eliminating the need to pre-order toughened glass panels weeks in advance. Most of Baresque's Lucere panels can be fabricated by the installer on-site, allowing last minute changes to be made, such as electrical point cut-outs etc.

MACHINING

In terms of hardness, Baresque Lucere panels are similar to aluminium or light alloys. It can be machined (cut, milled, turned or drilled) using typical tools for either wood or metal.

Recommendations for machining:

- Excessively fast machining causes local overheating, generating internal stresses which must subsequently be relieved by annealing;
- Best results will be achieved by using only very sharp tools, ensuring the efficient removal of swarf, not overheating the material;
- During machining, parts must be clamped properly to avoid any vibration;
- Strong vibration may result in a poor edge finish or broken sheet;

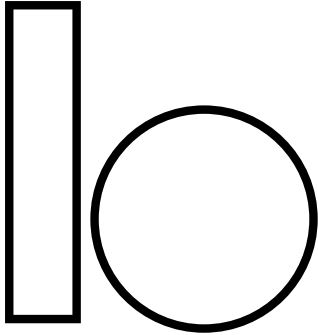

baresque

baresque.com.au
e info@baresque.com.au
p 1300 306 399

LUCERE

handling fabrication and installation guide (cont.)

CUTTING

When a sheet is being cut, the blade entry and exit stages are the most critical. A number of industrial cutting methods are suitable for Baresque panels. Circular saws are normally used for straight cuts, with bandsaws or router cutters for other shapes. Other more sophisticated methods such as lasers or CNC give excellent results.

Before cutting please ensure:

- Horizontally measure the top and bottom of the wall to determine the panel width required, as not all walls are square;
- Use a ballpoint pen to gently mark these measurements onto the protective film;
- Always support the Baresque panel, using a table or sheet of panel material. The use of a felt blanket, or the like, reduces scratching or indentation;
- Always ensure that all cutting blades are sharpened prior to use;
- For best results, especially when cutting panels for use with professional jointers, a high speed laminate cutter (30,000+rpm) with a 6mm blade should be used;
- For butt joining 2 or more panels edges should be cut from similar region of the sheet, due to variations in thickness, as per drawing below:

TABLE SAW

Normally a table saw has a downward blade rotation. If this is the case, cut panels with painted surface face up. If the blade rotation is up, cut panel with the painted surface down (therefore the blade is cutting into the painted surface, reducing 'chip out');

- Allow the panel to pass through the saw with even pressure – do not force the panel

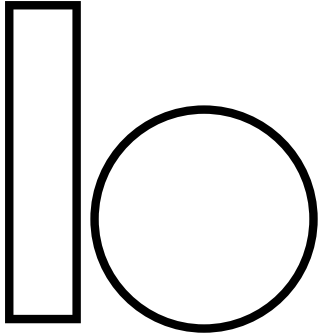

baresque

baresque.com.au
e info@baresque.com.au
p 1300 306 399

LUCERE

handling fabrication and installation guide (cont.)

CIRCULAR SAW

Circular saws give a straight, accurate cut. This is the most frequently used technique. When cut correctly, Baresque Lucere sheets have a clean surface.

Carbide-tipped blades are recommended for industrial use, for cutting piles of sheets. Normally the blade rotation of a circular saw is up. If this is the case, cut panels with painted surface down. If blade rotation is down, cut panel with painted surface face up (therefore the blade is cutting into the painted surface, avoiding 'chip out');

- Clamp a straight edge to the panel as a guide for the tool;
- Place a piece of timber material under the line you will be cutting. This supporting material is important as it helps reduce the chipping of the painted surface;
- Reduce the depth of cut to allow the blade to cut approximately 7mm through the sheet;
- Cut the panel using the circular saw, cutting slowly with a sharp, high quality tooth blade

HAND SAW

A fine tooth panel saw may be used to cut Baresque Lucere panels, with the painted surface face up;

Mark the panel for the cut, hold the blade of the hand saw at a very low angle, so that it is almost fit at to the edge of the board;

- Cut slowly and carefully with even strokes

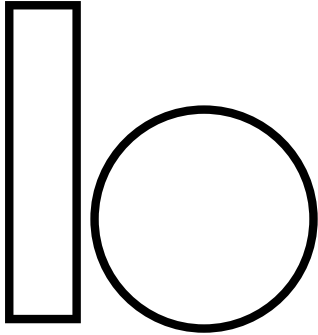

baresque

baresque.com.au
e info@baresque.com.au
p 1300 306 399

LUCERE

handling fabrication and installation guide (cont.)

JIGSAW

Jigsaws with blades suitable for wood or plastics can be used for short distances such as power point openings. Do not allow blade to overheat.

DRILLING AND OPENING

Drilling can be carried out with fixed or portable drilling machines, fitted with high speed, super-high speed or carbide-tipped steel drills for light metal, specially ground for Lucere panels.

The use of carbide-tipped drills is recommended, to obtain a high-grade finish on the sides of the holes. Best results will be achieved with a slow to medium drill speed.

- Drilled holes should be no closer than 50mm to the edge of the sheet;
- Larger openings should be no closer than the largest dimension of the opening away from the edge of the sheet

MILLING / ROUTERING

Milling can be used to obtain complex shapes with a clean, polished machine finish. Lucere sheets must be securely held to avoid vibration and a poor edge finish.

The rotation speed must be between 10,000 and 30,000 rpm, depending on the diameter and number of cutting edges used, and compressed air cooling may be helpful.

Feed rates of 3,000 are suitable for 4mm depth

Milling can be used for several operations such as:

- Cutting through

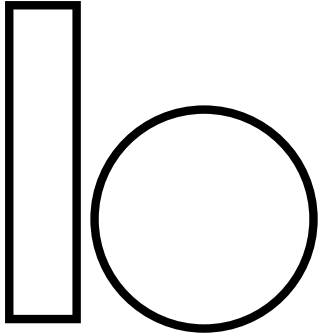

baresque

baresque.com.au
e info@baresque.com.au
p 1300 306 399

LUCERE

handling fabrication and installation guide (cont.)

- Engraving
- Finishing edges

FORMING

Some of Baresque's Lucere panels can be Formed (to be advised on application), the forming options are:

THERMOFORMING

Baresque Lucere panels that were manufactured using thermoplastic resin allow for complex shapes in heated state.

LINE BENDING

Create corners using this forming technique. Heat is applied to a straight edge and the Lumicor is bent to create an angle.

COLD FORMING

This technique is available for simple and large curves but requires a strong mechanical fixing system.

VACUUM FORMING

Is also available for some of Baresque's Lucere panels (to be advised on application)

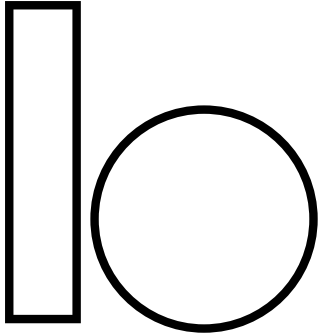

baresque

baresque.com.au
e info@baresque.com.au
p 1300 306 399

LUCERE

handling fabrication and installation guide (cont.)

installation

INSTALLATION CHECK LIST

Please inspect carefully upon receipt of Baresque Lucere panels, replacement policy does not allow for any labour charges incurred during or after fabrication on the defective materials.

The following list is a mandatory check list for fabricators when working with Baresque Lucere panels.

- Please check piece sizes, colour, design , finishing prior to fabrication or install.
- Surfaces need to be flattened prior to instal. For the tops of the cabinets must be flat and true to within 1/8" (3mm) of a flat surface.
- Clean surfaces with denatured alcohol before applying adhesive to prevent bonding failure.
- Never install mechanical fasteners (screws, nails, etc) into Baresque Lucere panels. Only panels supplied with a substrate can be mechanically fixed, to the substrate.

Baresque Panels are simple to install using construction adhesive and if desired double sided tape. It can be fixed directly to a timber frame wall or it can be laid over an existing wall lining, such as plaster board.

Baresque resin surface is easy to clean, impervious to moisture and will not support mould growth.

IMPORTANT NOTES

- Installation of the benchtops **MUST** be carried out by a competent person.
- Do not rush your installation. Take time and care during installation to achieve a professional finish.

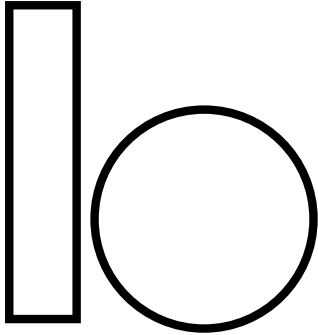

baresque

baresque.com.au
e info@baresque.com.au
p 1300 306 399

LUCERE

handling fabrication and installation guide (cont.)

- Protect your benchtop from damage by keeping all metal tools off the surface during the installation process.
- Under no circumstances must screws be used directly into Baresque panels.

Baresque panels can also be installed with different systems, such as:

NEUTRAL CURE SILICON

SPLIT BATTEN

DOUBLE SIDED TAPE

VELCRO TAPE

FULLY FRAMED

TOP AND BOTTOM FRAMED

PIN FIXING

CABLE SYSTEM

Every application requires special attention and if unsure of which fixing method to use please contact Baresque.

repairs and scratch removal:

LUCERE PANELS (GLOSS FINISH)

FINE SCRATCH REMOVER

(Novus 2) Removes fine scratches, haziness and abrasions from most plastics. With repeated use, NOVUS No. 2 restores faded and discoloured plastics.

Removes the damage instead of filling it in

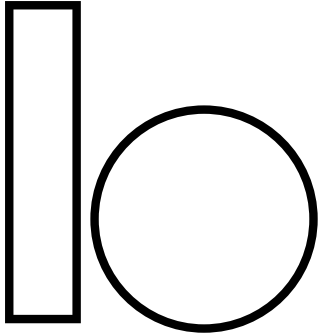

baresque

baresque.com.au

e info@baresque.com.au

p 1300 306 399

LUCERE

handling fabrication and installation guide (cont.)

Buffers out quickly

After restoring, seals with a coat of polish

Please follow suppliers recommendations.

LUCERE PANELS (GLOSS FINISH)

HEAVY SCRATCH REMOVER

(Novus 3) Removes heavy scratches and abrasions from most Lucere surfaces. Use when damage is too severe to be restored with NOVUS No. 2 polish.

Requires use of NOVUS No. 2 for final finishing

Not recommended for use on coated plastics

Please follow suppliers recommendations.

For assistance or recommendations on repairs for your Baresque panels please contact our Technical Support department at (02) 8081 8855.