

PATTERN 1
Name: OBLIQUE

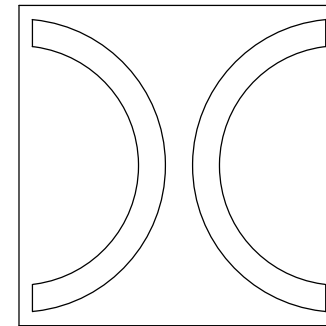

PATTERN 2
Name: CECE

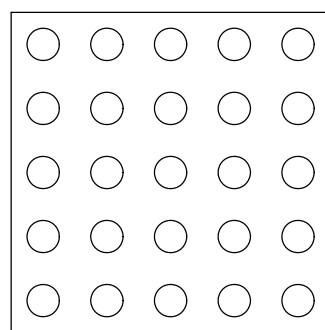
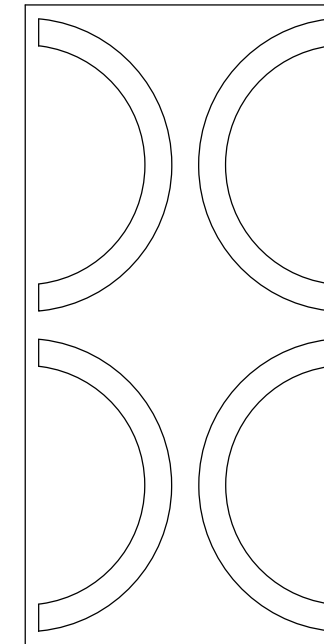

PATTERN 3
Name: POLKA FIVE

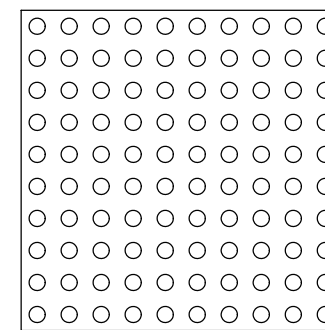
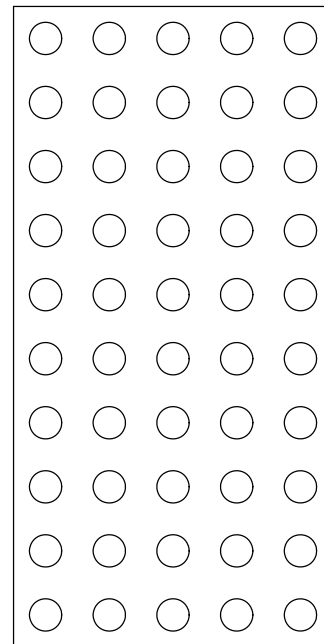

PATTERN 4
Name: POLKA TEN

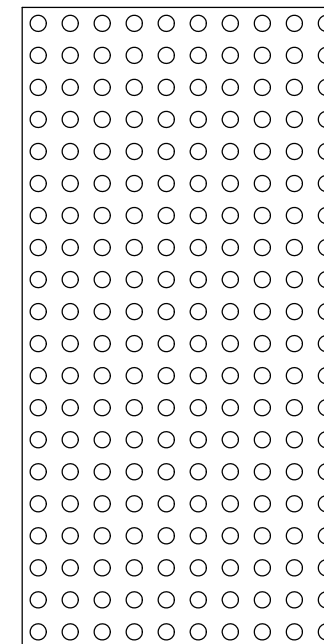

ALL DIMENSIONS ARE TYPICAL

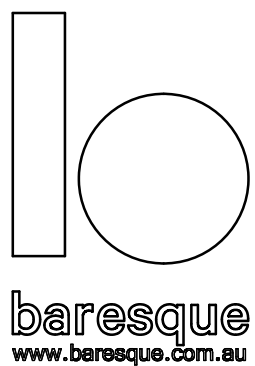

FINISHES
QTY:
thickness: 24mm
type: ZINTRA ACOUSTIC BOARD

design: VARIOUS
skin:
core: 24mm MDF

NOTES

CLIENTS APPROVAL

client
address
title ZINTRA PRESSED TILES

order
scale
date 15/03/2018
revision

SIGNATURE DATE

PLEASE MAKE SURE THAT ALL DIMENSIONS AND INFORMATION MATCHES THE PROJECT AND SIGN FOR APPROVAL

drawing 1/4

S:\Baresque Manufacturing\PRODUCTION\STANDARD PRODUCTS\ZINTRA\Zintra Pressed Tiles\PRESS TEMPLATES\

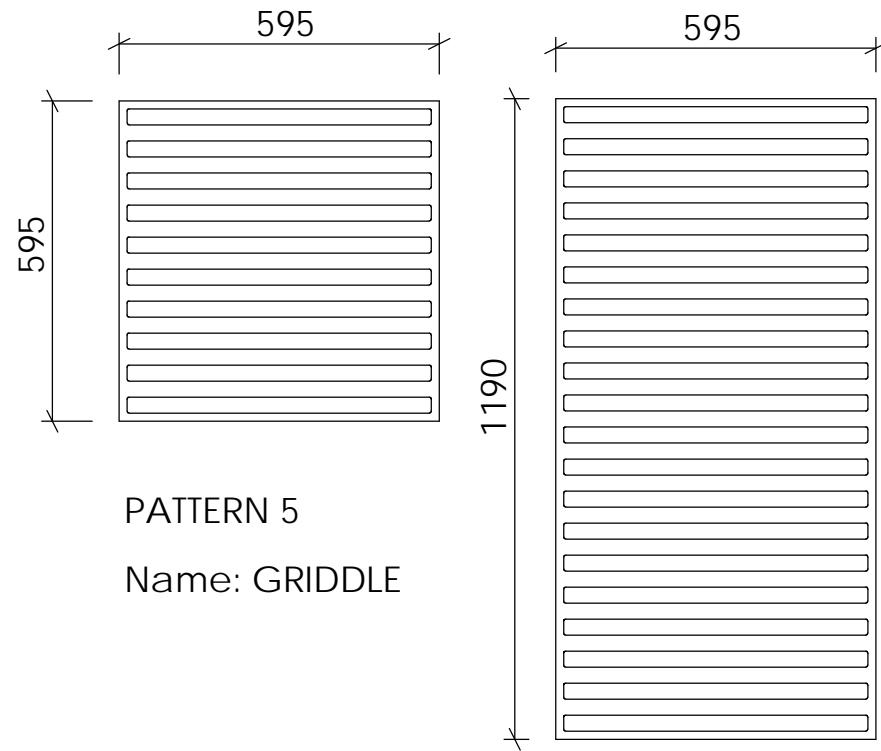

PATTERN 5
Name: GRIDDLE

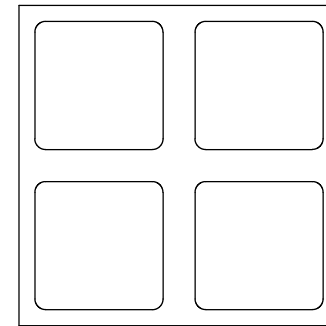

PATTERN 6
Name: QUADRA

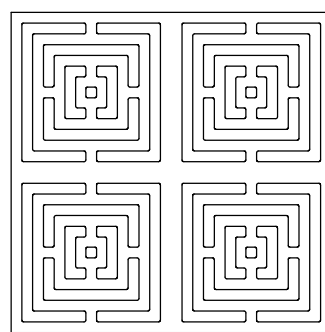
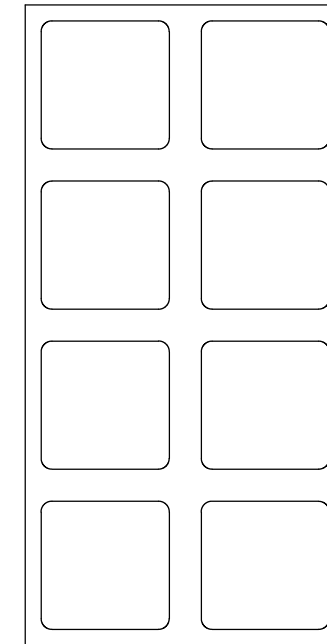

PATTERN 7
Name: FOCUS

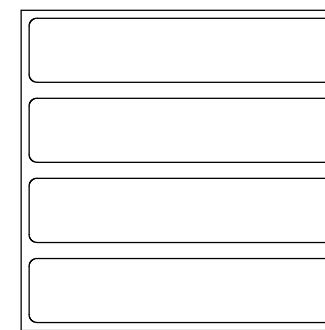
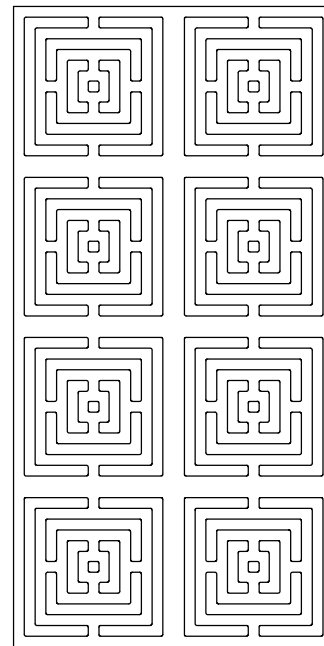

PATTERN 8
Name: BEAM

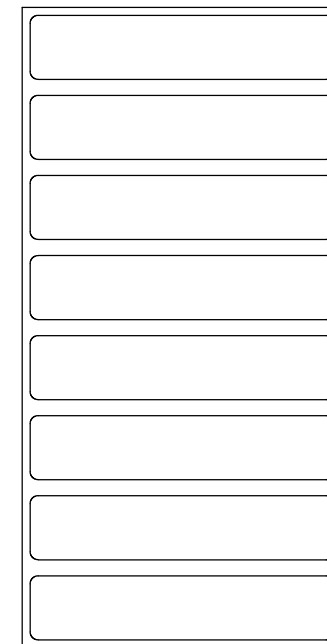

ALL DIMENSIONS ARE TYPICAL

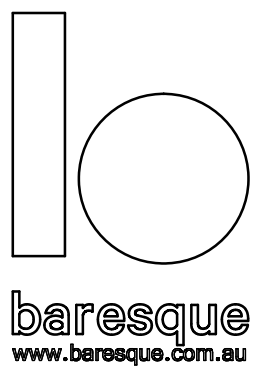

FINISHES
QTY:
thickness: 24mm
type: ZINTRA ACOUSTIC BOARD

design: VARIOUS
skin:
core: 24mm MDF

NOTES

CLIENTS APPROVAL

client
address
title ZINTRA PRESSED TILES

order
scale
date 15/03/2018
revision

SIGNATURE DATE

PLEASE MAKE SURE THAT ALL DIMENSIONS AND INFORMATION MATCHES THE PROJECT AND SIGN FOR APPROVAL

drawing 2/4

S:\Baresque Manufacturing\PRODUCTION\STANDARD PRODUCTS\ZINTRA\Zintra Pressed Tiles\PRESS TEMPLATES\