

TILE

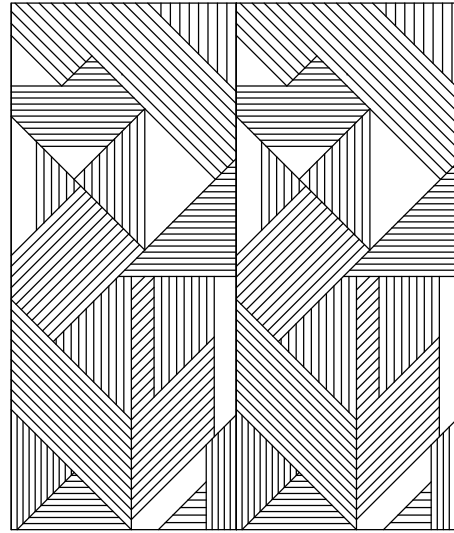

MIRROR

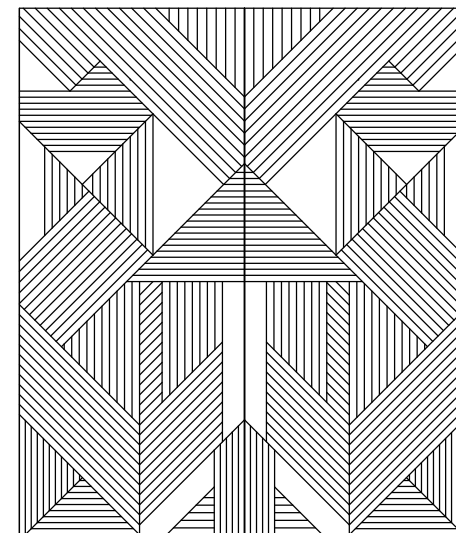

RANDOM FLIP AND ROTATE

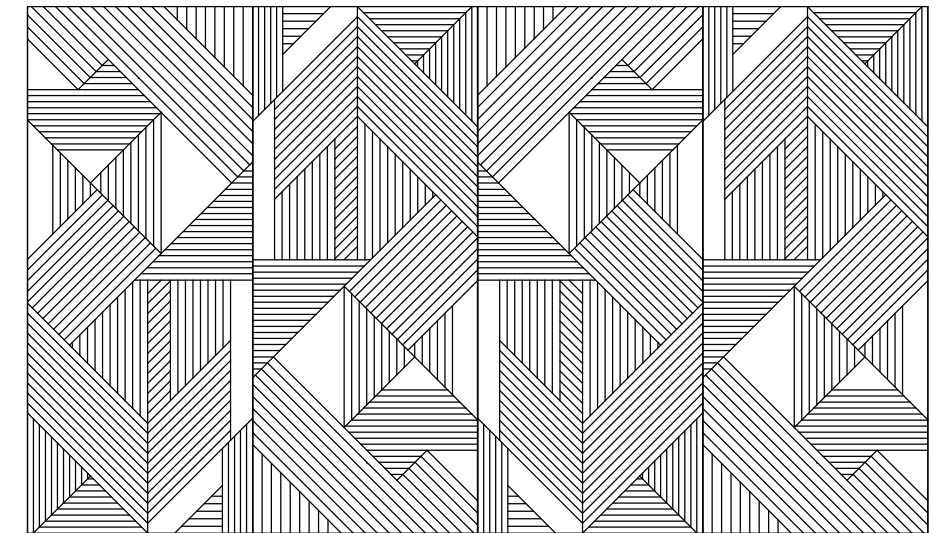

HORIZONTAL TILE

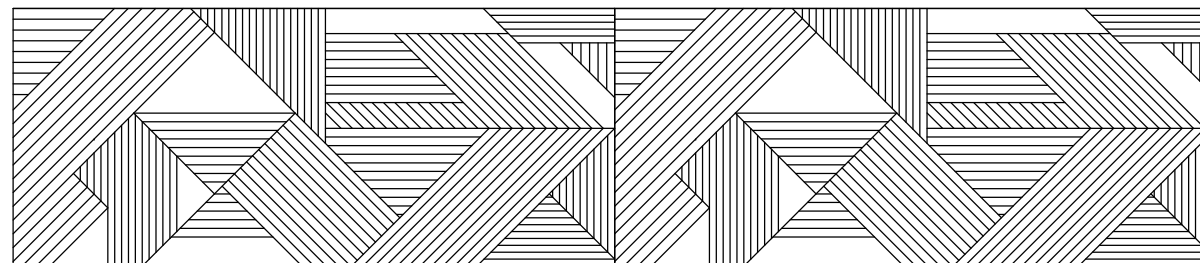

HORIZONTAL MIRROR

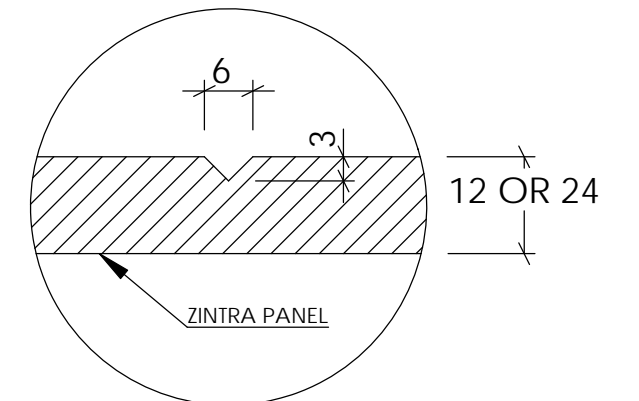
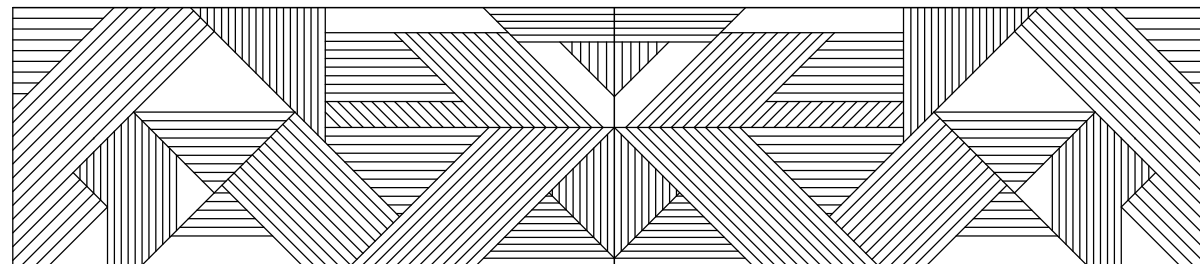

V-GROOVE DETAIL VIEW

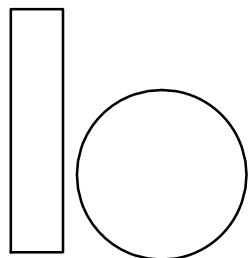

**baresque**  
www.baresque.com.au

FINISHES  
QTY: ....  
thickness: ....  
type: ZINTRA ETCH

design: TESSELATE  
skin: ....  
core: ....

**NOTES**

3MM DEEP V GROOVE

**CLIENTS APPROVAL**

\_\_\_\_\_  
SIGNATURE      DATE

PLEASE MAKE SURE THAT ALL DIMENSIONS  
AND INFORMATION MATCHES THE  
PROJECT AND SIGN FOR APPROVAL

client ....  
address ....  
title ZINTRA ACOUSTIC ETCH

order ....  
scale 1:1  
date 5/09/2018  
revision

\_\_\_\_\_  
drawing  
1/20 -TESSELATE

S:\Baresque Manufacturing\PRODUCTION\STANDARD PRODUCTS\ZINTRA\Zintra Etch\